

Name

Date

姓名: _____

日期: _____

親子小任務:「學習個人衛生」(拼拼圖)

請家長與幼兒一起在圖畫上沿線剪出各塊拼圖,然後將拼圖貼在貼圖區的工作紙上,完成拼圖後,請家長與幼兒說出拼圖內容,讓幼兒知識個人衛生習慣。

K2-Simple Learning Task:「Learning personal hygiene」(Puzzle)

Cut along the dotted lines carefully. Once cut, put the picture together. Discuss the content of the picture with your children.

拼圖參考圖 Reference Picture:衛生防護中心 Centre for Health Protection

資料來源 Source : https://www.chp.gov.hk/files/her/hand_hygiene_pamphlet.pdf

拼圖 A Puzzle A

拼圖 B Puzzle B



拼圖 A Puzzle A

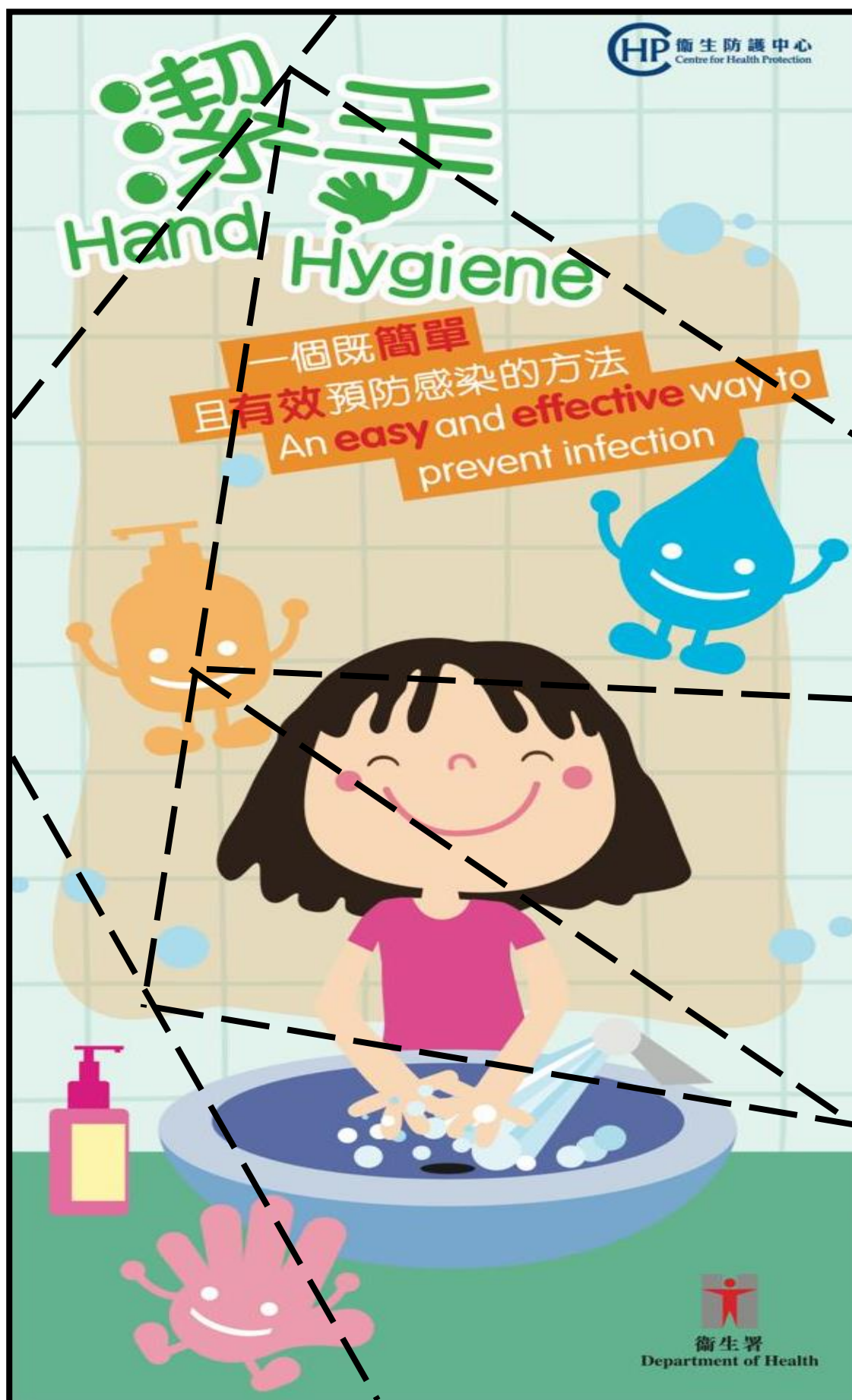

拼圖 B Puzzle B

健康建議
Health Advice

經常保持
雙手清潔
Perform hand hygiene frequently

洗手時應以視液和清水清潔雙手
搓手最少20秒
Wash hands with liquid soap and water, and rub for at least 20 seconds

打噴嚏或咳嗽時
應用紙巾掩蓋口鼻，然後徹底清潔雙手
Cover your mouth and nose with tissue paper when sneezing or coughing, then wash hands thoroughly

當出現發燒或呼吸道感染病徵，
應戴上外科口罩及盡早向醫生求診
When having a fever or respiratory symptoms, wear a surgical mask and seek medical advice promptly

時刻保持良好的個人及環境衛生
Maintain good personal and environmental hygiene at all times

貼圖區 Puzzle Zone

拼圖 Puzzle (A)



拼圖 Puzzle (B)

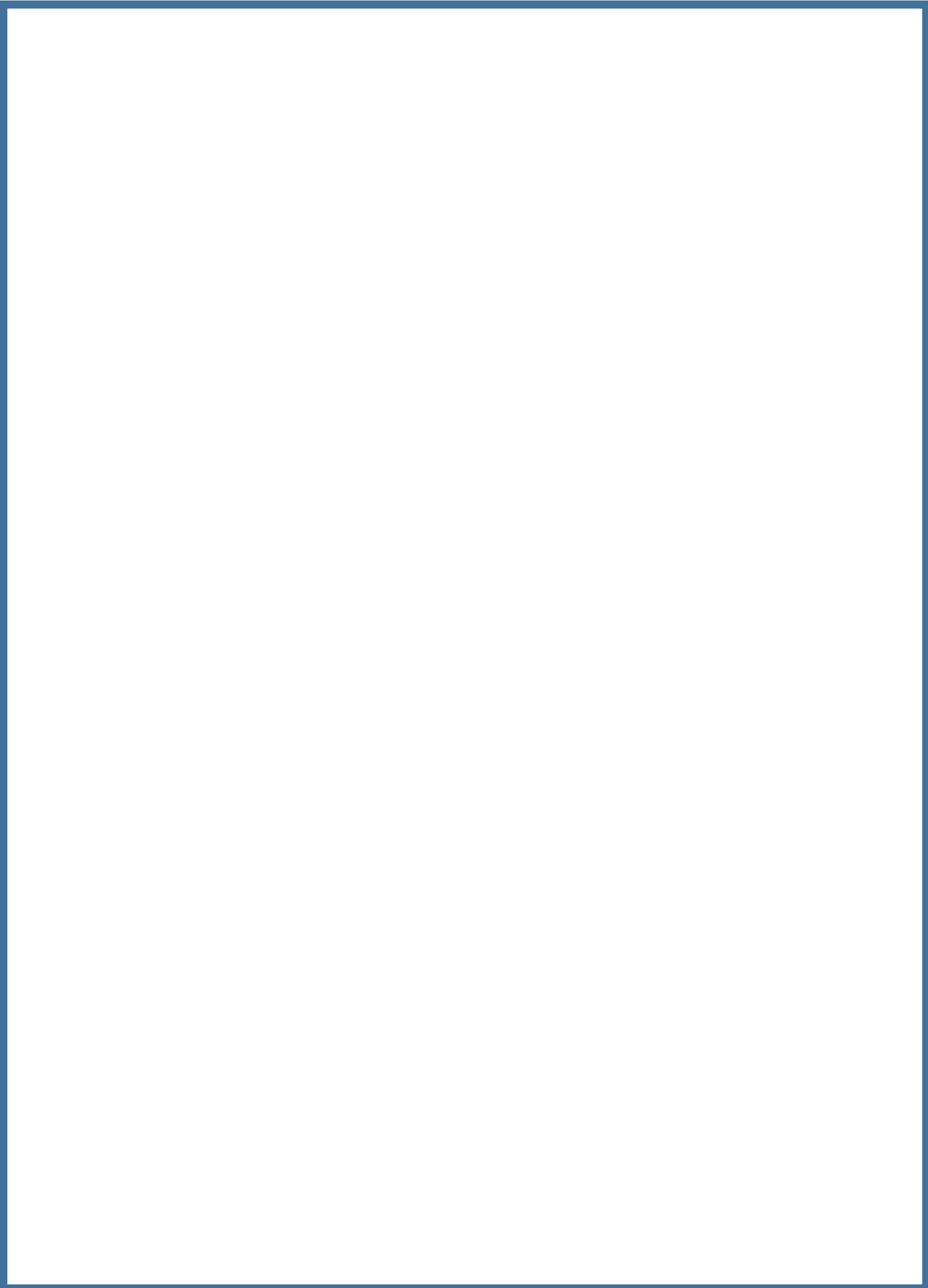

日期：_____

Date

短句

趣趣樂！

媽媽養了一隻貓。



Mum has a cat.

金魚住在魚缸。



The goldfish lives in a fish tank.

請根據下列句子，在圖案內畫出正確的動物。

媽媽養了一隻（貓）。

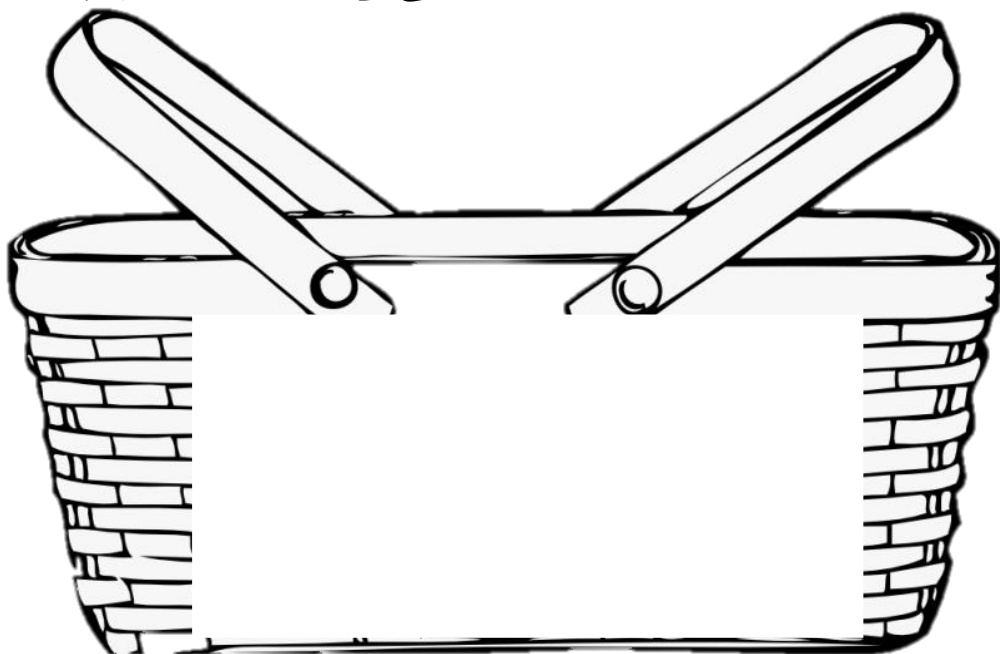

（金魚）住在魚缸。

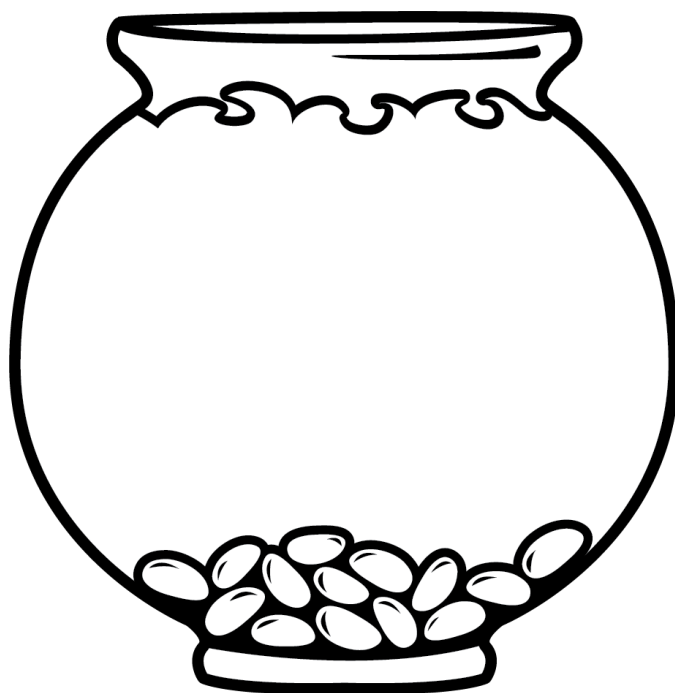

請把皮球填上顏色，然後數數皮球的數量並把相同的數字圈出來。

Please colour the ball, then count the number of balls and circle the correct number.

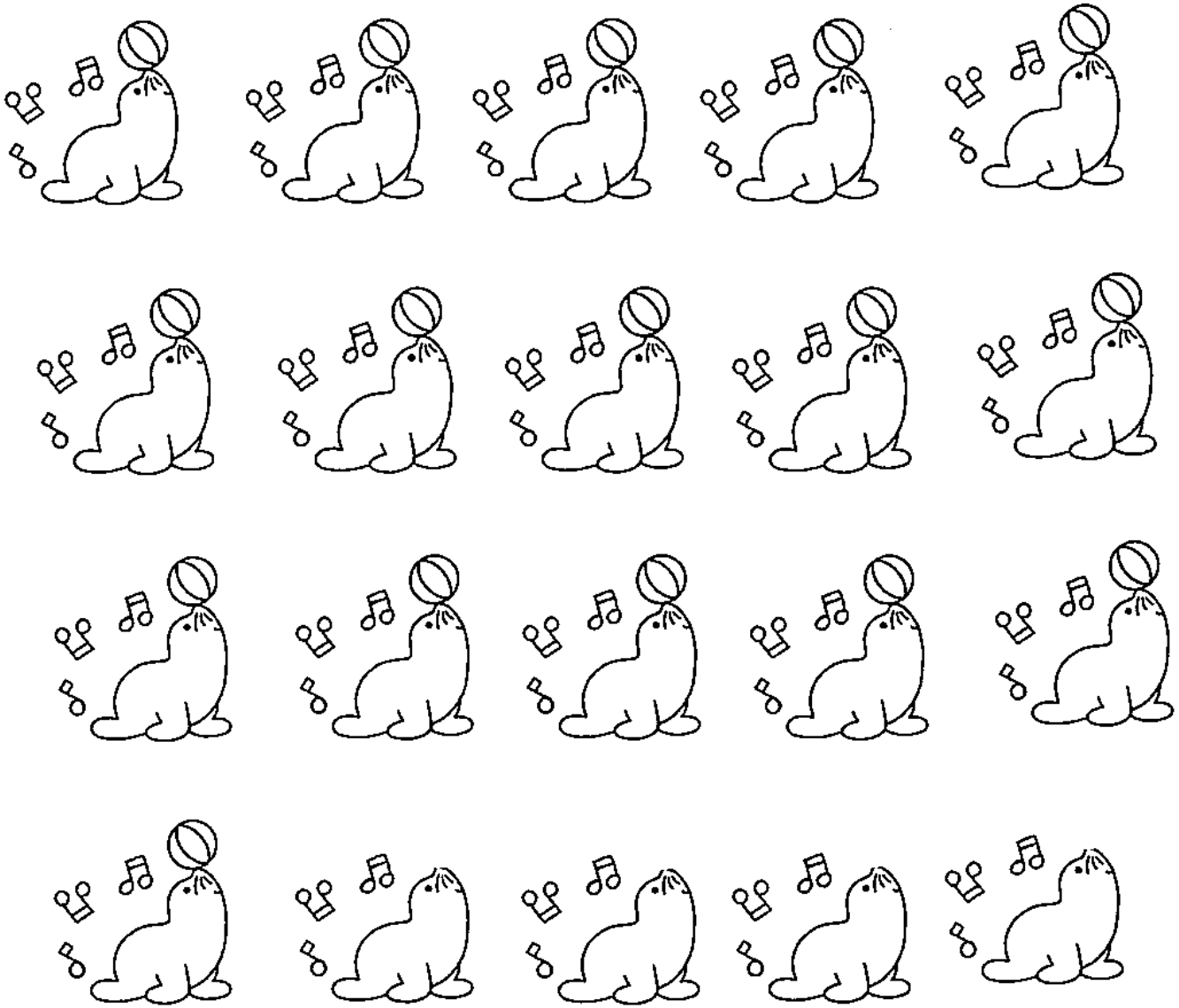

14	15	16
----	----	----

Date

日期: _____

1-20

1

10

11

20

Tim's little seed

Date: _____

1. Vocabulary

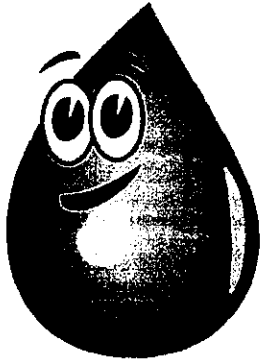

water



growing

2. Read the sentences with your parents.

I put the seed in the water.

My seed is growing.

My plant is growing.

3. Draw leaves and a flower for the growing plant.

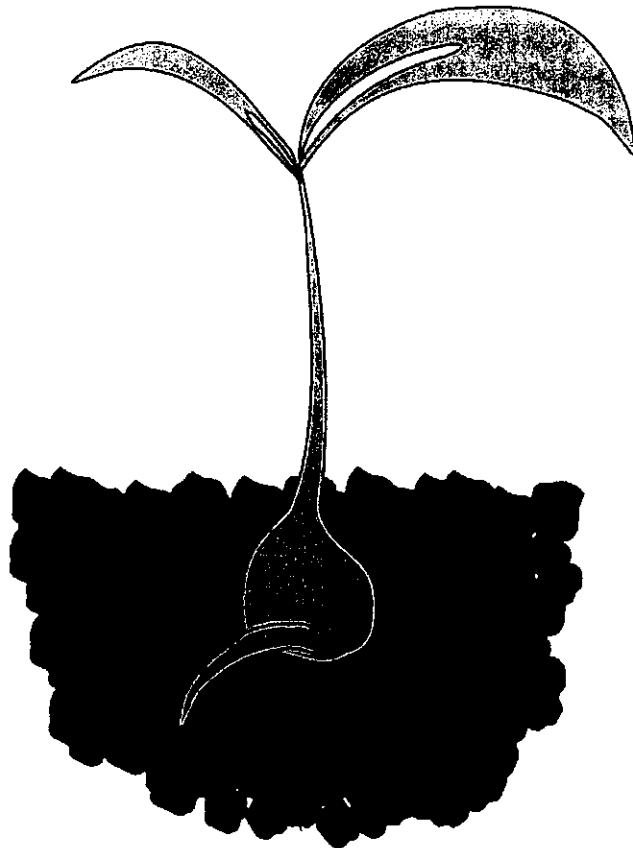

2019-2020 年度下學期小任務活動(4)
Simple Learning Task Activity (4) Second Term

Name

姓名: _____

Date

日期: _____

停課期間，小朋友可利用時間多做運動。請觀看影片和老師一起跳舞。

Children are encouraged to spend time to do exercises during class suspension period.

Please watch the videos and dance with teachers together!

Song 1: Dancing Queen (Link: <https://youtu.be/SdQqPyNOITo>)



Song 2: Skidamarink (Link: <https://youtu.be/657jgRRjdT4>)

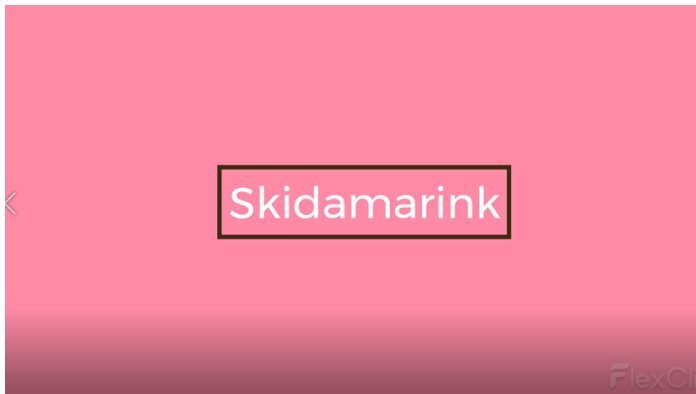

Song 3: 撓個大石頭 (Link: <https://youtu.be/IXePf7DfsoE>)

